



**Surface Mount Transient Voltage Suppressor
600 Watt Peak Pulse Power
P6SMB Series**

**1. Features**

- For surface mounted applications in order to optimize board space
- Halogen-Free
- RoHS compliant
- Typical maximum temperature coefficient $\Delta VBR=0.1\% \times VBR @ 25^{\circ}C \times \Delta T$
- Low profile package
- Built-in strain relief
- Glass passivated junction
- Low inductance
- Excellent clamping capability
- Repetition Rate (duty cycle):0.01%
- Fast response time: typically less than 1.0ps from 0 Volts to BV for unidirectional types
- Typical IR less than 1uA above 12V
- High Temperature soldering: 260°C/40 seconds at terminals
- Plastic package has Underwriters Laboratory Flammability 94V-0
- Matte Tin Lead-free plated

2. Mechanical Data

Case: JEDEC DO214AC. Molded plastic over glass passivated junction
Terminal: Solderable per MIL-STD-750, Method 2026
Polarity: Color band denoted positive end (cathode) except Bidirectional
Standard Packaging: 12mm tape (EIA STD RS-481)
Weight: 0.003 ounce, 0.093 gram

3. Devices For Bipolar Application

For Bidirectional types, use C or CA as suffix; suffixes without A, the VBR is $\pm 10\%$.
(e.g. P6SMB6.8C, P6SMB550CA)
Electrical characteristics apply in both directions

4. Maximum Ratings and Characteristics(25°C)

Rating	Symbol	Value	Units
Peak Pulse Power Dissipation on 10/1000 μ s waveform (Note 1,2 ,Fig.1)	P_{PPM}	Minimum 600	Watts
Peak Pulse Current of on 10/1000 μ s waveform (Note 1, Fig.3)	I_{PPM}	SEE TABLE 1	Amps
Peak Forward Surge Current,8.3ms Single Half Sine-Wave Superimposed on Rated Load(JEDEC Method) (Note2,3)	I_{FSM}	100	Amps
Operating junction and Storage Temperature Range	T_J, T_{STG}	-55 to + 150	°C

Notes :

- 1.Non-repetitive current pulse , per Fig. 3 and derated above $T_A = 25^{\circ}C$ per Fig. 2
- 2.Mounted on 5.0mm x 5.0mm (0.03mm thick) Copper Pads to each terminal.
- 3.8.3ms single half sine-wave , or equivalent square wave, Duty cycle = 4 pulses per minutes maximum.

NOTE : Specification subject to change without notice.



Part Number		Device Marking Code		Reverse Stand-Off Voltage $V_{RWM}(V)$	Breakdown Voltage $V_{BR}(V) @I_T$		Test Current $I_T (mA)$	Maximum Clamping Voltage $V_C(V)@I_{PP}$	Maximum Peak Pulse Current $I_{PP} (A)$	Maximum Reverse Leakage $I_R @ V_{RWM} (\mu A)$
					Min	Max				
Uni-Polar	Bi-Polar	Uni	Bi							
P6SMB6.8A	P6SMB6.8CA	6V8A	6V8C	5.8	6.45	7.14	10	10.5	58.1	1000.0
P6SMB7.5A	P6SMB7.5CA	7V5A	7V5C	6.4	7.13	7.88	10	11.3	54.0	500.0
P6SMB8.2A	P6SMB8.2CA	8V2A	8V2C	7.0	7.79	8.61	10	12.1	50.4	200.0
P6SMB9.1A	P6SMB9.1CA	9V1A	9V1C	7.8	8.65	9.55	1	13.4	45.5	50.0
P6SMB10A	P6SMB10CA	10A	10C	8.6	9.50	10.50	1	14.5	42.1	10.0
P6SMB11A	P6SMB11CA	11A	11C	9.4	10.50	11.60	1	15.6	39.1	5.0
P6SMB12A	P6SMB12CA	12A	12C	10.2	11.40	12.60	1	16.7	36.5	5.0
P6SMB13A	P6SMB13CA	13A	13C	11.1	12.40	13.70	1	18.2	33.5	1.0
P6SMB15A	P6SMB15CA	15A	15C	12.8	14.30	15.80	1	21.2	28.8	1.0
P6SMB16A	P6SMB16CA	16A	16C	13.6	15.20	16.80	1	22.5	27.1	1.0
P6SMB18A	P6SMB18CA	18A	18C	15.3	17.10	18.90	1	25.5	24.2	1.0
P6SMB20A	P6SMB20CA	20A	20C	17.1	19.00	21.00	1	27.7	22.0	1.0
P6SMB22A	P6SMB22CA	22A	22C	18.8	20.90	23.10	1	30.6	19.9	1.0
P6SMB24A	P6SMB24CA	24A	24C	20.5	22.80	25.20	1	33.2	18.4	1.0
P6SMB27A	P6SMB27CA	27A	27C	23.1	25.70	28.40	1	37.5	16.3	1.0
P6SMB30A	P6SMB30CA	30A	30C	25.6	28.50	31.50	1	41.4	14.7	1.0
P6SMB33A	P6SMB33CA	33A	33C	28.2	31.40	34.70	1	45.7	13.3	1.0
P6SMB36A	P6SMB36CA	36A	36C	30.8	34.20	37.80	1	49.9	12.2	1.0
P6SMB39A	P6SMB39CA	39A	39C	33.3	37.10	41.00	1	53.9	11.3	1.0
P6SMB43A	P6SMB43CA	43A	43C	36.8	40.90	45.20	1	59.3	10.3	1.0
P6SMB47A	P6SMB47CA	47A	47C	40.2	44.70	49.40	1	64.8	9.4	1.0
P6SMB51A	P6SMB51CA	51A	51C	43.6	48.50	53.60	1	70.1	8.7	1.0
P6SMB56A	P6SMB56CA	56A	56C	47.8	53.20	58.80	1	77.0	7.9	1.0
P6SMB62A	P6SMB62CA	62A	62C	53.0	58.90	65.10	1	85.0	7.2	1.0
P6SMB68A	P6SMB68CA	68A	68C	58.1	64.60	71.40	1	92.0	6.6	1.0
P6SMB75A	P6SMB75CA	75A	75C	64.1	71.30	78.80	1	103.0	5.9	1.0
P6SMB82A	P6SMB82CA	82A	82C	70.1	77.90	86.10	1	113.0	5.4	1.0
P6SMB91A	P6SMB91CA	91A	91C	77.8	86.50	95.50	1	125.0	4.9	1.0
P6SMB100A	P6SMB100CA	100A	100C	85.5	95.00	105.00	1	137.0	4.5	1.0
P6SMB110A	P6SMB110CA	110A	110C	94.0	105.00	116.00	1	152.0	4.0	1.0
P6SMB120A	P6SMB120CA	120A	120C	102.0	114.00	126.00	1	165.0	3.7	1.0
P6SMB130A	P6SMB130CA	130A	130C	111.0	124.00	137.00	1	179.0	3.4	1.0
P6SMB150A	P6SMB150CA	150A	150C	128.0	143.00	158.00	1	207.0	2.9	1.0

NOTE : Specification subject to change without notice.



P6SMB160A	P6SMB160CA	160A	160C	136.0	152.00	168.00	1	219.0	2.8	1.0
P6SMB170A	P6SMB170CA	170A	170C	145.0	162.00	179.00	1	234.0	2.6	1.0
P6SMB180A	P6SMB180CA	180A	180C	154.0	171.00	189.00	1	246.0	2.5	1.0
P6SMB200A	P6SMB200CA	200A	200C	171.0	190.00	210.00	1	274.0	2.2	1.0
P6SMB220A	P6SMB220CA	220A	220C	185.0	209.00	231.00	1	328.0	1.9	1.0
P6SMB250A	P6SMB250CA	250A	250C	214.0	237.00	263.00	1	344.0	1.8	1.0
P6SMB300A	P6SMB300CA	300A	300C	256.0	285.00	315.00	1	414.0	1.5	1.0
P6SMB350A	P6SMB350CA	350A	350C	300.0	332.00	368.00	1	482.0	1.3	1.0
P6SMB400A	P6SMB400CA	400A	400C	342.0	380.00	420.00	1	548.0	1.1	1.0
P6SMB440A	P6SMB440CA	440A	440C	376.0	418.00	462.00	1	602.0	1.0	1.0
P6SMB480A	P6SMB480CA	480A	480C	408.0	456.00	504.00	1	658.0	0.9	1.0
P6SMB510A	P6SMB510CA	510A	510C	434.0	485.00	535.00	1	698.0	0.9	1.0
P6SMB530A	P6SMB530CA	530A	530C	477.0	503.50	556.50	1	725.0	0.8	1.0
P6SMB540A	P6SMB540CA	540A	540C	486.0	513.00	567.00	1	740.0	0.8	1.0
P6SMB550A	P6SMB550CA	550A	550C	495.0	522.50	577.50	1	760.0	0.8	1.0

For bidirectional type having V_{rwm} of 10 volts and less, the IR limit is double.



5. Ratings and Characteristic Curves ($T_A=25^\circ\text{C}$ unless otherwise noted)

Fig. 1 - Peak Pulse Power Rating

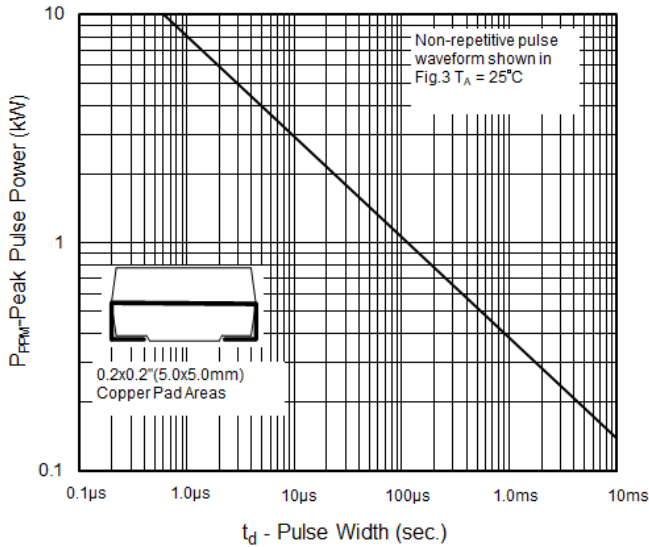

Fig.2 - Pulse Derating Curve

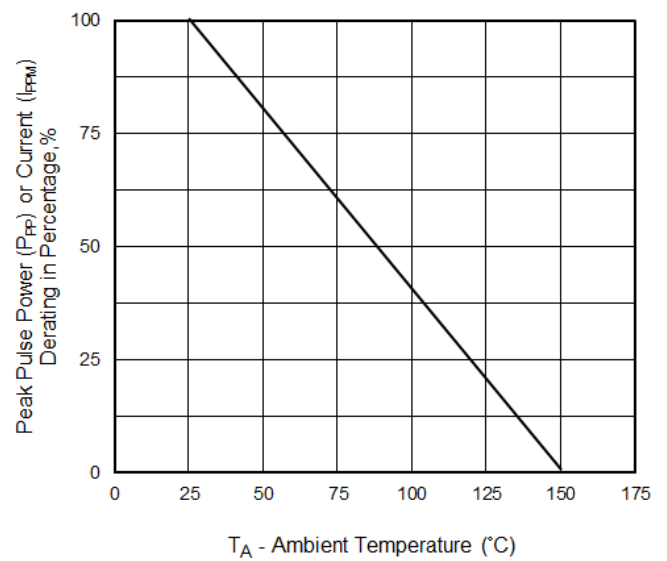

Fig.3 - Pulse Waveform

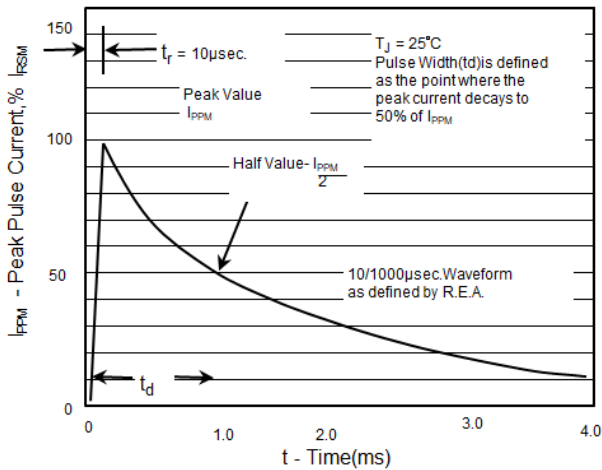

Fig. 4 - Typical Junction Capacitance

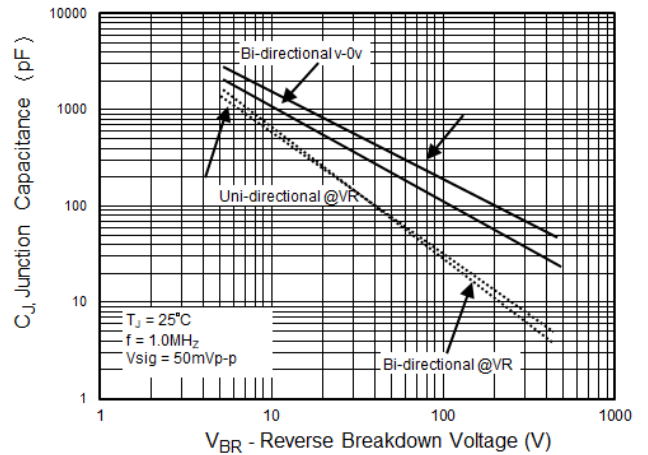

Fig. 5 - Steady State Power Derating Curve

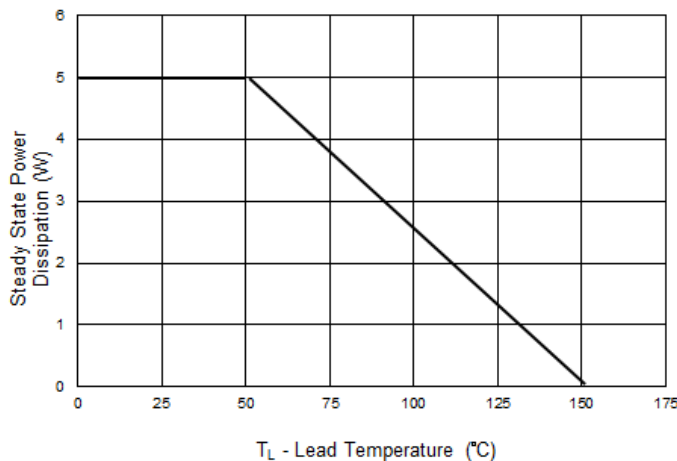
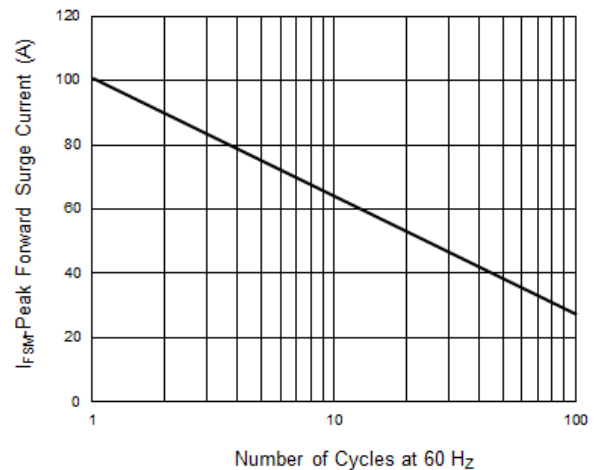

Fig.6 - Maximum Non-repetitive Forward Surge current uni-directional only



NOTE : Specification subject to change without notice.



6. Dimension

DO-214AA (SMB J-Bend)

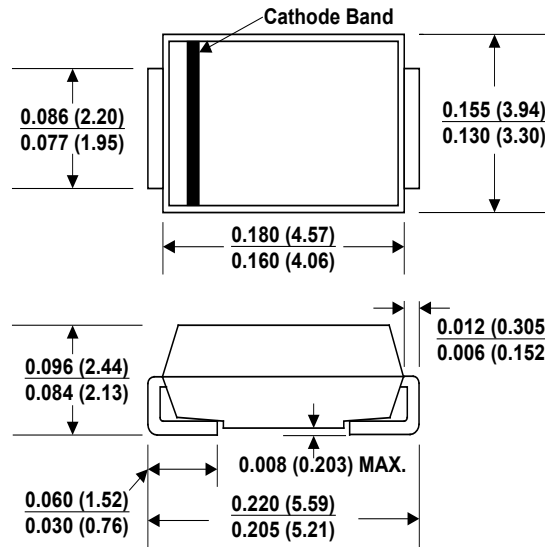

Dimensions in inches and(millimeters)

7. Part Numbering and Marking System

Part Numbering System

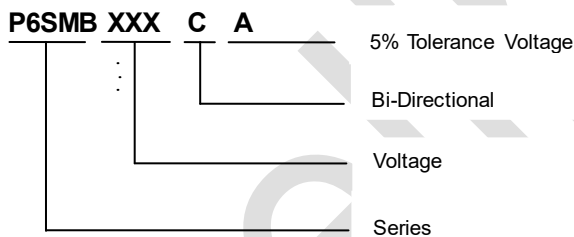

Marking System

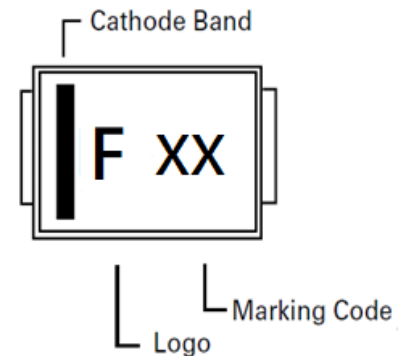

8. Packaging Specification

Part Number	Component Package	Quantity	Packaging Option	Packaging Specification
P6SMBxxxXX	DO-214AA	3000	Tape & Reel - 12mm/13" tape	EIA STD RS-481
P6SMBxxxXX	DO-214AA	500	Tape & Reel - 12mm/ 7" tape	EIA STD RS-481

NOTE : Specification subject to change without notice.